

THORUP

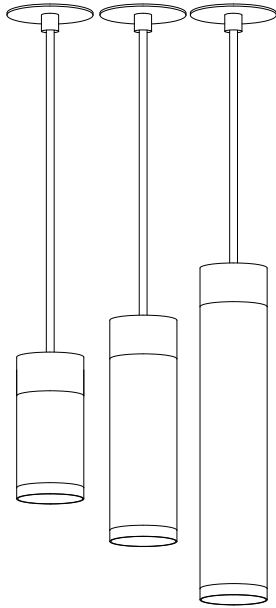

PATRONE LIGHTING USER GUIDE

CRAFTED IN COPENHAGEN

Enjoy your new Patrone Lighting! Please ensure a smooth installation process and make the most of your product by following these instructions carefully.

Please note that each lamp is meticulously crafted in Copenhagen, resulting in a unique product with potential variations

It's important to install and use your Patrone Lighting correctly and only for its intended purpose. We recommend consulting a qualified electrician for installation.

Thorup cph cannot be held liable for any damages resulting from improper installation or modification of the lamp.

Technical Specifications:

LED GU10, max 4 Watts

Compatible with bulbs of energy classes A++

Designed for indoor use only

For any inquiries or assistance, please don't hesitate to contact us at info@thorupcph.com

CONTENT

- Ceiling Rose prepared for box fit installation

SPARE PART NEEDED

- Bulb Type: LED GU10

INSTRUCTIONS

- Please read the instructions carefully before commencing assembly.
- Installation should be carried out in accordance with local safety regulations.
- This product is intended for indoor interior use only.
- In order to prevent damage, please check walls for cables before drilling holes.

MATERIALS

Brass is a natural material that develops a unique patina over time, enhancing its character. Exposure to air and humidity will cause brass to oxidize and discolor, which adds to its distinctive charm.

Due to the handcrafted process, each lamp may have slight variations, adding to its uniqueness.

CARE GUIDE

This product is made from solid brass. For routine cleaning, gently wipe with a soft, dry cloth. Avoid using sponges, polishing creams, or abrasive cleaners. To maintain the brightness and remove spots and stains from the solid brass version, we recommend using our Brass Care Kit.

For additional details on product care and spare parts, please visit thorupcopenhagen.com/care-guide



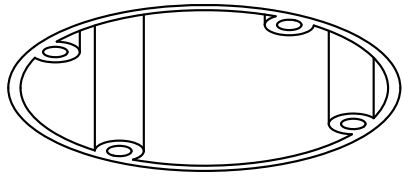
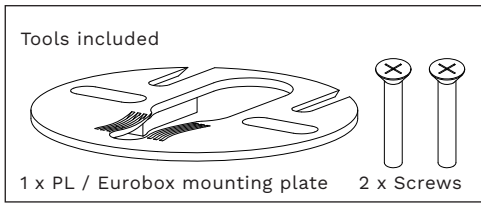

Step 1

This ceiling rose is prepared to be fitted directly onto a pre-installed PL/Eurobox.

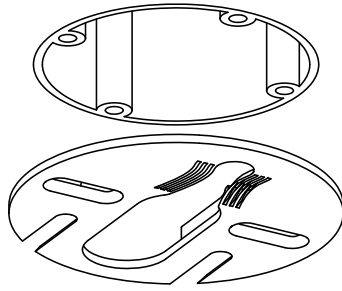

Step 2

Use the included screws to mount the PL/Eurobox mounting plate onto the PL/Eurobox.

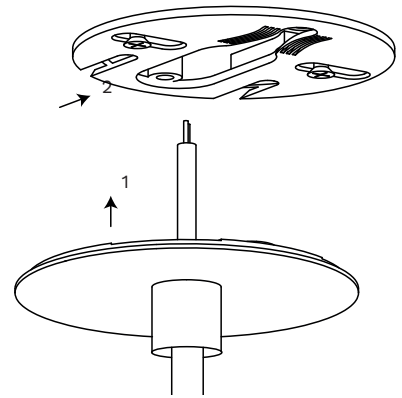

Step 3

Feed the electrical wires from the ceiling box through the center hole of the ceiling rose and slide the ceiling rose into place.

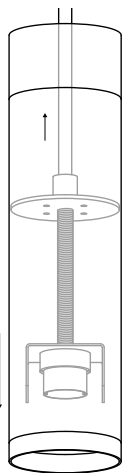

Step 4

Carefully pull the cord upwards to release the insert from the fixture. We recommend using the white gloves for the solid brass and nickel-plated brass version.

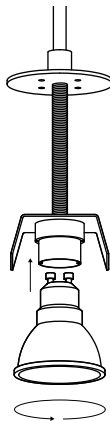

Step 5

Install the LED bulb firmly by pushing it upwards and carefully turn clockwise until it is fixed in place.

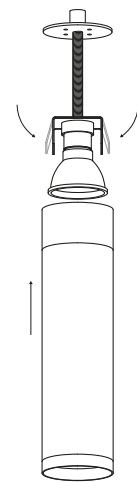

Step 6

Install the shade, by gently pressing the two sides inwards to enclose the insert with the fixture.

Spacing guide

We recommend using these measurements as a guide when installing the Patrone Pendant Lamp above your kitchen island or dining table.

